

SB2WEB24

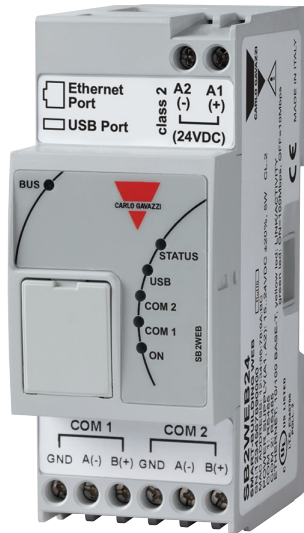

SB2WEB BACnet Controller



Benefits

- **Configurable by software.** Building automation functions and energy data logging are configurable by software.
- **Spread sheets compatible.** All data exports are compatible with Excel or other spread sheets.
- **Modularity.** The system is composed by modules so that each installation can be precisely and easily sized.
- **Scalability.** New modules can be progressively integrated into the system according to the application needs.
- **Fast and easy installation.** Completely free topology, no special cable required, no screen or twist. It can go for 2 km and even further with repeaters.
- **Remote control.** All functions can be remotely controlled while the owner is away and moreover a series of actions can be automatically performed.
- **User-friendly.** The system is user-friendly and really anyone can easily learn to master it.

Description

The SB2WEB24 programmable BACnet Controller is the brain and central unit in Carlo Gavazzi's integrated concept for HVAC and lighting control in smart buildings.

On one hand the SB2WEB24 can manage the complete lighting control system based on Dupline® sensors/actuators and DALI actuators, and on the other hand it can operate as Dupline®-BACnet/IP gateway thus allowing DDC controllers to use Dupline® I/O modules and sensors as decentralized I/O via BACnet objects.

The SB2WEB is also able to operate as Modbus/TCP slave.

The SB2WEB provides functions for control of lighting, blinds, temperature, logic, scheduling, sequencing, alarms and data logging.

The functions can be controlled, monitored and operational parameters changed via BACnet objects.

Applications

Smart Dupline® is a bus system that offers unique solutions for a wide range of applications in building automation, industrial automation, water distribution, energy management, railway systems and many other areas.

Main features

- BACnet Controller for HVAC and lighting systems
- BACnet/IP objects are automatically created for all Dupline® and Energy Meter data points
- Micro PC with Web-server
- Linux embedded operating system
- Two RS485 communication ports (Modbus)
- One Ethernet port
- Two multi purpose USB 2.0 ports
- Data logging
- Internal data storage up to 30 years in a 4GB memory

Structure

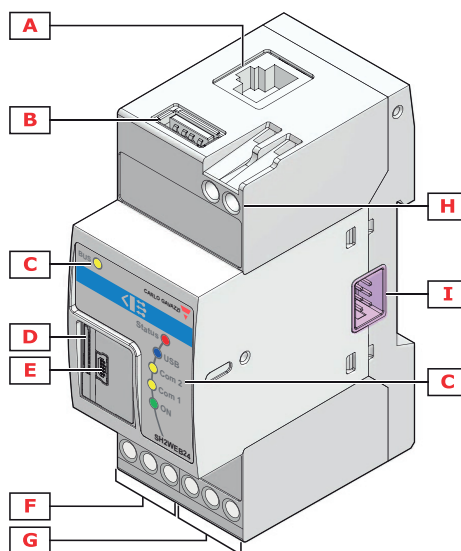

Element	Component	Function
A	Ethernet port	Displaying the web interface and transmitting data to remote systems via wired connection
B	USB Port (Host function)	IP address programming
C	Information LED	Indicating the following statuses: Local bus connection (BUS) Status (STATUS) USB key (USB) RS485 COM1 port (COM1) RS485 COM2 port (COM2) Module power
D	Micro SD memory card slot	IP address programming
E	Mini-USB port (Device function)	Connecting a PC to view the web interface if there are connection problems via Ethernet port and permitting backup to PC
F	RS485 COM1 port terminals	Connecting to any Modbus device
G	RS485 COM2 port terminals	Connecting to any Modbus device
H	Power terminals	Powering the module
I	Local bus port (left side and right side)	Left side: connecting the SH2DSP24. Right side: connecting the SH2MCG24, SH2WBU230N, SH2DUG24.



Features

General

Material	Noryl, self-extinguishing V-0 (UL94)
Dimensions	2-DIN module
Weight	150 g
Protection grade	Front: IP40; Screw terminals: IP20
Dielectric strength	4000 VAC RMS for 1 minute
Rejection (CMRR)	>65 dB, from 45 to 65 Hz
Terminal	12 screw-type; Section: 1.5 mm ² maximum; Torque

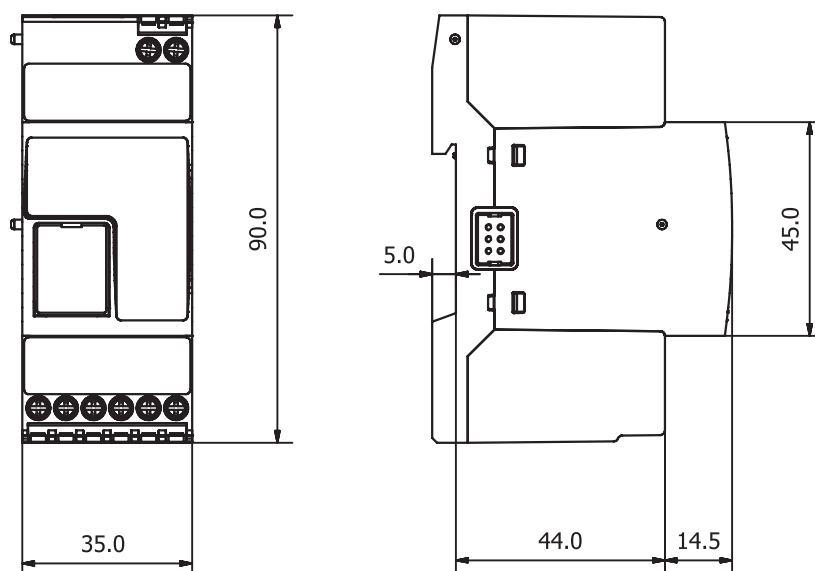

Environmental

Operating temperature	-20° to +50°C (-4° to 122°F)
Storage temperature	-30° to +70°C (-22° to +158°F)
Humidity (non-condensing)	20 to 90% RH

Compatibility and conformity

Electromagnetic compatibility (EMC) - immunity	EN 61000-6-2
Electromagnetic compatibility (EMC) - emissions	EN 61000-6-3
Approvals	

Power Supply

Power Supply	Overvoltage cat. II (IEC 60664-1, par. 4.3.3.2); Rated operational voltage: 15 to 24 VDC \pm 20%
Rated operational power	5 W
Protection for reverse polarity	Yes
Connection	A1 (+) and A2 (-)

Inputs/outputs insulation

Type of input/output	DC power supply	RS485 COM1	RS485 COM2	Ethernet	USB port "H"	USB port "D"	SH2UMMF124 and SH2DSP24
DC power supply	-	2 kV	2 kV	0.5 kV	0 kV	0 kV	0 kV
RS485 COM1	2 kV	-	0.5 kV	2 kV	2 kV	2 kV	2 kV
RS485 COM2	2 kV	0.5 kV	-	2 kV	2 kV	2 kV	2 kV
Ethernet	0.5 kV	2 kV	2 kV	-	0.5 kV	0.5 kV	0.5 kV
USB port "H"	0 kV	2 kV	2 kV	0.5 kV	-	0 kV	0 kV
USB port "D"	0 kV	2 kV	2 kV	0.5 kV	0 kV	-	0 kV
SH2DSP24	0 kV	2 kV	2 kV	0.5 kV	0 kV	0 kV	-

- **0kV:** inputs / outputs are not insulated.
- **2kVrms:** EN61010-1, IEC60664-1 - over-voltage category III, pollution degree 2, double insulation on systems with max. 300Vrms to ground.
- **0.5kVrms:** the insulation is functional type Mounting.

Main hardware characteristics

Memory	<ul style="list-style-type: none"> • Flash (data): 4 GB • RAM 128 MB (internal) • File system: external micro SD or USB memory stick only: FAT32 (VFAT). Up to 2 GB in case of micro SD type and from 4 to 16 GB in case of micro SDHC type (removable), industrial type (-25°C to 85° suggested)
Communication ports	<ul style="list-style-type: none"> • RS485: 2 ports • Ethernet: 1 port, for Internet/LAN connection
Auxiliary bus (HS BUS)	<ul style="list-style-type: none"> • Right side: compatible with SH2MCG24, SH2WBU230x and SH2DUG24 units
USB ports	<ul style="list-style-type: none"> • 1, "B" device function • 1, "E" host function

HS Bus

Bus type	RS485 high speed bus
Function	Connection to master channel generator module (SH2MCG24, SH2WBU230x and SH2DUG24)
Number of slave	Maximum 7
Connection	By local bus on the right side Note: All the SH2MCG24, SH2WBU230x and SH2DUG24 modules have to be connected on the right side of the SH2WEB24.

Auxiliary Internal Bus

Function	Connection to SH2UMMF124 and SH2DSP24 modules
Number of slave	Maximum 1
Connection	By local bus on the left side Note: On this bus only one GSM module SH2UMMF124 or SH2DSP24 can be connected.

Main functions

Configuration	The configuration and the programming of SH2WEB24 and all other modules connected to either the same local bus or to the managed RS485 ports can be carried out using the Sx configuration software. For the installation of the configuration, please refer to the Sx tool software manual.
Clock	<ul style="list-style-type: none"> • Functions: universal clock and calendar with automatic synchronisation enabling through internet connection. • Battery life: 10 years.
Event management and messaging	<ul style="list-style-type: none"> • E-mails configuration: setting of recipient addresses and relevant subject, sender address, sender name, SMTP server, username of SMTP server and password of SMTP server. • Actions: the user can program according to which events the emails and relevant attachments have to be sent. • SMS configuration: setting of phone numbers: - events; - commands; - information on request.
Logging	<ul style="list-style-type: none"> • Data: the data are accessible and downloadable using Ethernet communication port. • Function description: all the variables gathered from both dupline modules and Modbus modules are stored individually into the internal memory. • Stored data type: variables: V, A, W, kWh, temperatures, light levels, wind speed, humidity, in general all the analogue values collected from the smart Dupline modules. • Storage interval: selectable from 1 minute to 24 hours. • Sampling management: the sample stored within the selected time interval results from the continuous average calculation of the measured values. The average is calculated with an interval within two following measurements of approx. 2s. • Storage duration: before overwriting: depending on the storage interval. • Number of variables: see "Stored set of variables." • Data format: variables, date (dd:mm:yy) and time (hh:mm:ss). • Events: the data are accessible and downloadable using Ethernet communication port: see "Memory Management" table. • Function description: all the events gathered from the smart Dupline functions can be stored individually into the internal memory. • Number of events: till memory is full. • Data reset: the reset can be carried out through the proper command in the Sx tool. • Data format: event, date (dd:mm:yy) and time (hh:mm:ss).
Memory	<p>Total available memory for database and events: 1.8 GB. Yearly grouped data: 6.0Mb. Single row: 150 bytes.</p> <p>Notes: When the 1.8 GB limit is reached, the 5% of the oldest data are deleted to provide the space for new data. The memory used data are relevant to the internal memory only.</p>



Ports

Ethernet

Rated inputs	HTTP
IP configuration	Static IP/Netmask/Default gateway, DHCP
DNS	Primary and secondary DNS as a static or dynamic management (using DHCP server if configured).
WEB server	Port: 80; N. of connections: 3
TOOL	N. of connections: 1
MODBUS TCP/IP	N. of connections: 5
Connections	RJ45 10/100 BaseTX; Max. distance: 100m
Insulation	See "Insulation between inputs and outputs" table

RS485

Number of ports	2
Purpose	COM1: Modbus slave/up to 64 generic modbus devices COM2: up to 64 generic modbus devices
Connections	2-wire. Max. distance 600 m
Addresses	247
Protocol	MODBUS
Data (bidirectional)	All data
Data format	Selectable: 1 start bit, 7/8 data bit, no/odd/even/ parity, 1/2 stop bit
Baud-rate	Selectable: 9600, 19200, 38400, 115200, bits/s
Driver input capability	1/8 unit load Up to 256 nodes on a network
Insulation	See the table "Insulation between inputs and outputs"

USB

Type	High speed 2.0
Connections	"A" type as "Host" function on the top of the housing. "Mini A" type as "Device" function on the front of the housing protected by front cover.
Host function (USB)	Available on the "B" USB port only.
Device function (mini USB)	Available on the "E" USB port only, can be connected to a PC to perform the following functions: service port for firmware upgrading. Note: both USB and mini USB ports are working in parallel, so relevant port functions can work simultaneously.
Working type	Hot swap
Communication speed	60MB/s (480Mbits/s)

▶ Micro SD slot

Type	Industrial (from -25 to +85 °C / -13 to + 185 °F)
Capacity	SD: up to 2 GB SDHC: 4–16 GB
Function	IP address programming

▶ Mini-USB

Type	High speed USB 2.0 - mini
Mode	Hot swap
Speed	60 MB/s
Function	<ul style="list-style-type: none"> • Accessing the web interface without Ethernet connection* • Configuring the system, updating firmware, and downloading measured data and events
Condition of use	Can be used in parallel with USB port.

Note*: this requires a specific driver be installed in the PC. The driver is downloadable from Carlo Gavazzi website.



Communication protocols

Introduction

The Sx2WEB module collects data from the field, it process collected data and communicates to remote systems. Different TCP/IP based communication protocols can be used. All protocols are supported by wired and wireless connection and managed on both local network (LAN) and remote one (WAN).

Protocol overview

Protocol	Type	Transmission mode from Sx2WEB	Data
HTTP (web browser)	Standard	Pull	All
FTP	Standard	Push	All
Modbus TCP/IP	Standard	Pull	All

Inbound TCP/IP communication

TCP/IP port number	TCP/IP port description	Purpose
80/443	HTTP/HTTPS	Access to the internal web-server
52325	SSH	Remote service (reserved to support personnel)

Outbound TCP/IP communication

TCP/IP port number	TCP/IP port description	Purpose
23	DNS	Domain name resolution
37	NTP	Network time services access
21 (selectable)	FTP	Data upload to FTP server (csv, xlsx, xml file)
25 (selectable)	SMTP	Email message dispatching

Modbus TCP communication

TCP/IP port number	TCP/IP port description	Purpose
502 (selectable)	Modbus (TCP)	Modbus TCP data communication: both master and slave

BACnet

TCP/IP port number	TCP/IP port description	Purpose
47808 (selectable)	BACnet	Server

 **Connection to the configuration tool**

TCP/IP port number	Purpose
10000/10001/10002/80/48007/52325	Connection to the configuration software First connection: the Sx2WEB is by default programmed as DHCP client. It has, anyway, a fixed secondary IP address: 192.168.253.254



Connection Diagrams

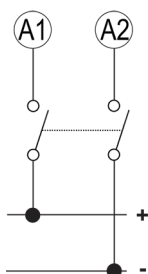

Fig. 1 Power supply

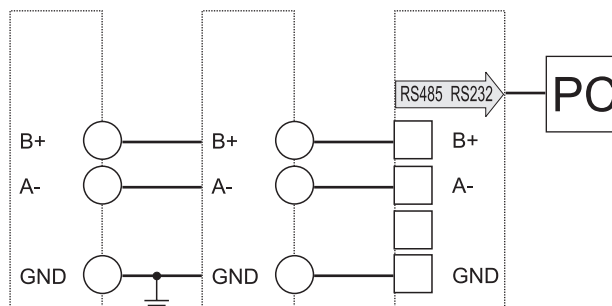

Fig. 2 RS485 port COM1_COM2

References

Further reading

Information	Document	Where to find it
Sx2WEB installation guide	System manual	www.productselection.net/MANUALS/UK/system_manual.pdf
Sx2WEB software manual	Sx tool manual	www.productselection.net/MANUALS/UK/sx_tool_manual.pdf
Sx2WEB wireless installation manual	Wireless manual	http://www.productselection.net/MANUALS/UK/wireless_manual.pdf

Order code



SB2WEB24

CARLO GAVAZZI compatible components

Purpose	Component name/code	Notes
Controller	Sx2WEB24	
Bus generator	SH2WBU230N, SH2MCG24, SH-2DUG24	

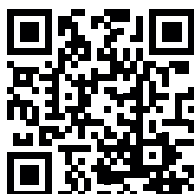

COPYRIGHT ©2015
Content subject to change. Download the PDF: www.productselection.net